



Jack Richeson  
& Co., Inc.

# Framing Guide

Stretcher  
Linear  
Custom



# BEST

Stretcher Bars by Richeson

*Made in the USA since 1981.*



[www.richesonart.com](http://www.richesonart.com)  
920.738.0744  
800.233.2404

# What you need to know

when ordering custom BEST stretcher bars

## What is a "Custom" Order?

A custom order is any stretcher bar order requiring these item numbers:

1. **SPE (Special)** : Any stretcher bars/cross braces *not* listed in the JRC Price List (Example: 59-3/8" x 62" exact)
2. **#894500 (Bar Cut Charge)** per bar for SPE.
3. **#894501 (Bar Notch Charge)** per bar. Notching of cross braces where braces intersect.
4. **SK (Splice Kit)** : Allows two aluminum bars to be joined together for longer-than-stock length and ease of shipping long lengths. 1 Kit required per splice.
5. **SKBR (Lap Joint)** : Allows cross braces to be joined for long lengths and shipping ease.
6. **SET (Set Up)** : Predrilling holes, assembly instructions & cross brace bracket mounting.

**NOTE:** All Custom Bar Orders *must have a sketch* attached to show cross braces. Manufacturer will determine placement of splicing and lap-joint; however, it must be noted on the order. Layouts that include splices or lap-joints *must have an even number of cross braces*. Refer to page 12. Questions? Contact our sales team for help on placing an order.

## Aluminum Pro Combination Series: Aluminum Pro, Aluminum Gallery Wrap, and Aluminum HD

Required parts for assembly:

1. **#890048 BEST Corner Keys**
  2. **#895020-04 Aluminum Corners\***
- \*While lengths up to 36" can be assembled with 1 pack of Aluminum Corners (#895020-04), lengths over 36" require 2 packs for stability.**

Beneficial Accessories

- **#895007-04 12" Hardboard Corners** – Guarantees that the frame remains square and corners together. Can be reused or reattached to frame after adjusting the BEST Corner Keys. Set of 4.
- **#895008-04 8" Hardboard Corners** also available.
- **SK Splice Kit** – Use for lengths longer than 144" or for shipping capability, 1 Kit per splice

## Heavy Duty, Medium Duty, and Light Duty Bar Orders

**Standard Carton Quantities: Heavy Duty – 6/box, Medium Duty – 12/box, Light Duty – 12/box**

Beneficial Accessories

- **#895005 L/M Wood Keys & #895004 HD Wood Keys** – Wood Keys can be used to expand the corner assembly to correct a sagging canvas. 8 pack at no charge. Please specify if desired.
- **#890048 BEST Corner Keys** – Simplifies tightening of canvas both at the time of stretching or later as a result of aging and seasonal variations in humidity and temperature.
- **#895007-04 12" Hardboard Corners & #895008-04 8" Hardboard Corners** – Ensure the frame remains square and corners together.

## Cross Braces

Each time you have a cross brace you will need a Cross Brace Bracket Pack. 2/pack

- Order 1 – **#895015 Cross Brace Bracket** per cross brace as a No Charge Item.
- **#894501 Bar Notch Charge:** Any time cross braces intersect, there are 2 bar notch charges.
- Use the same length cross brace as the stretcher bar. We make the allowance in length.
- **SKBR Lap Joint** is needed if length exceeds 144" or shipping concern.
- Please specify notching and include drawing. See page 12 for helpful Cross Brace layout.

**NOTE:** All BEST Stretcher Bar are cut 1/8" shorter than the measurement listed for industry standards. This is to ensure that the assembled frame with canvas will fit into a picture frame. If exact measurements are required, please call 800.233.2404.



BEST art products have been proudly made in the USA since 1981.

## CONTACT US!

- richesonart.com
- 800.233.2404  
920.738.0744
- 800.233.2545  
920.738.9156
- Jack Richeson & Co.  
JRC BEST Bars
- Jack Richeson
- @jrcBESTbars



**Shipping Tip:** UPS can handle up to 96" lengths (8 feet). Lengths 97" and longer may require truck shipment.

# Displays & Custom Bars

## Why BEST bars?

Jack Richeson & Co. offers the finest stretcher bars. We are dedicated to ensuring you receive a consistent, quality product that is always in stock with on-time shipments and superior customer service.

Museum-quality bars:

- Made from only the finest raw materials
- Bars must be free from knots and completely straight
- All bars are designed so that the canvas is a full 1/2" from the bar
- Profile eliminates "ghosting" on the canvas
- Rounded back edges reduce surface friction allowing for a smoother, tighter draw of the canvas

## Custom Bars

- Order stretcher bars in fractional inches.  
Example of custom size: 56-1/2" exact by 72-1/2" exact
- Allow 3 working days in factory on custom orders of 1 - 5 frames.
- Allow 5 working days in factory on 6 frames and up.
- Jack Richeson & Co., Inc. recommends a cross brace every 36". See guide on back page.

When ordering cross braces, *please include a line drawing* of layout desired as shown below.

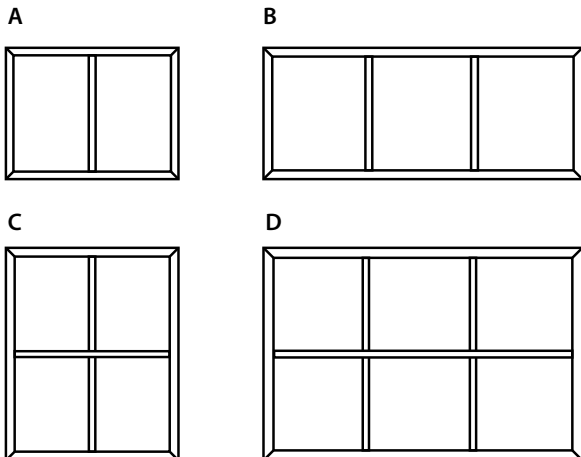

Designs with overlapping cross braces require notching of the bars at each intersection. A notching charge applies to each groove cut – Item #894501. Contact the JRC sales department for a quote at 920.738.0744.

### BEST Stretcher Bar Displays

- Perfect for stores and galleries with limited space
- Place two displays back to back and offer your customers more options
- Bars are held firmly in place in specially designed egg crate openings

- #890992 Empty Gallery Wrap Rack
- #890993 Light-Duty Rolling Bar Assortment
- #890994 Medium-Duty Rolling Bar Assortment
- #890995 Heavy-Duty Rolling Bar Assortment

*Please call for assortment contents.*



*Please request a BEST easel and furniture catalog to see our full line of BEST easels and taborets. All BEST products are U.S.A.–Made.*

# Linear Stock

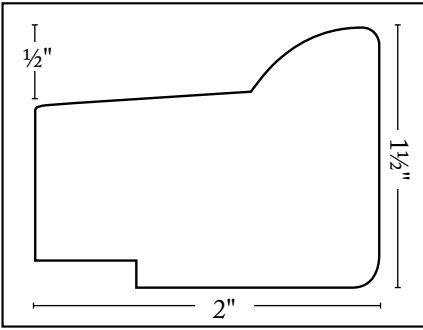

Cross-section of Heavy-duty Stretcher.  
**#899400 Heavy Duty Linear Stock**  
 8', 10', 12' Lengths

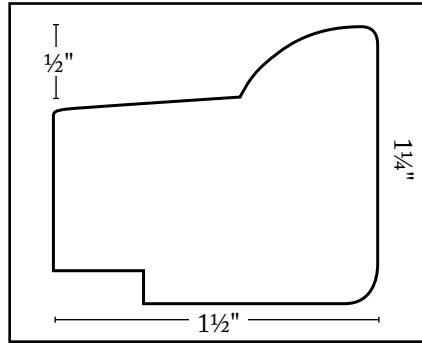

Cross-section of Medium-duty Stretcher.  
**#890700 Medium Duty Linear Stock**  
 8', 10', 12' Lengths

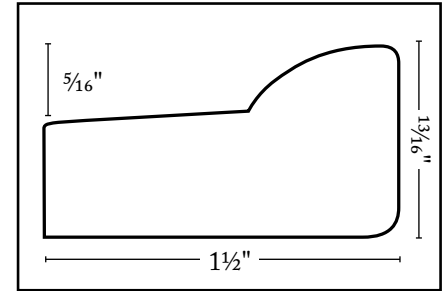

Cross-section of Lightweight Stretcher.  
**#894400 Light Duty Linear Stock**  
 8', 10', 12' Lengths

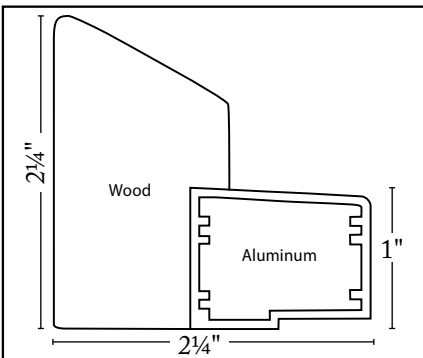

Cross-section of Aluminum Gallery Wrap.  
**#896000 Aluminum Gallery Wrap Linear Stock**  
 8', 10', 12' Lengths

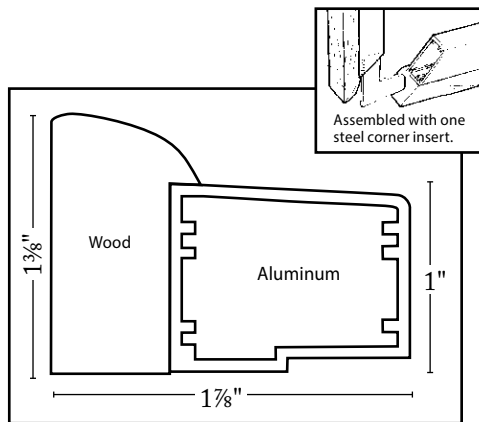

Cross-section of Aluminum Pro.  
**#893500 Aluminum Pro Linear Stock**  
 8', 10', 12' Lengths

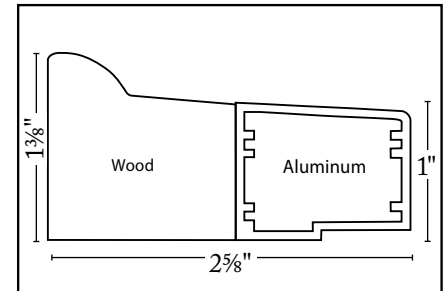

Cross-section of Aluminum HD.  
**#884190 Aluminum HD Linear Stock**  
 8', 10', 12' Lengths

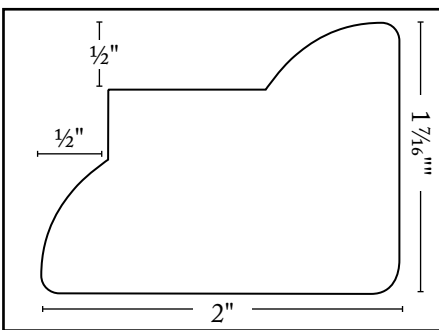

Cross-section of Heavy Duty Double Profile.  
**#899401 Double Profile Bar Linear Stock**  
 12' Lengths only

- Like two bars in one!
- Same great quality
- Same high rounded profile

## Strainer vs. Stretcher

A Strainer Bar frame is a permanently joined, rigid frame that has no method of expansion. Many companies will use this method of mitering the ends and v-nailing or gluing the frame together as it is more cost effective. The drawback is that, should the canvas slacken due to environmental conditions, the canvas will have to be removed and re-stretched with the potential of damaging the canvas.

A Stretcher Bar frame is constructed for expandable, keyable corners using wooden keys or BEST Corner Keys. Retensioning is easily done should the canvas become loosely wrinkled. This is the desired method for those working with fine art or giclées.

**920.738.0744**  
**for more information**  
**F.O.B. Kimberly, WI**

**Shipping Tip:** UPS can handle up to 96" lengths (8 feet).  
 Lengths 97" and longer may require truck shipment.

# BEST Stretcher Bars

*Museum-quality stretcher bars for the professional*

## **Heavy-duty Stretcher Bars**

The Heavy-duty bar is made of pine that has been finger spliced. Finger splicing is a method of bonding pieces of lumber together to form a very long, straight bar. Since the spliced joints are actually stronger than the natural wood, we can now get longer, stronger and straighter bars than ever before. First designed for the construction industry, this high tech method yields better bars than ever before. Perfect for gallery wraps.

### **Heavy-duty Bars (Box of 6)**

Stock sizes available in 1" increments from 8" - 144"

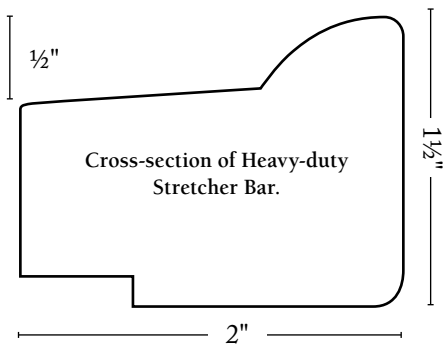

### **Medium-duty Bars (Box of 12)**

Stock sizes available in 1" increments from 8" - 72"

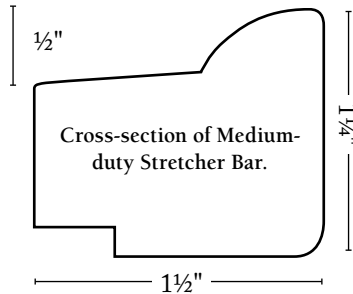

### **Light-duty Bars (Box of 12)**

Stock sizes available in 1" increments from 8" - 60"

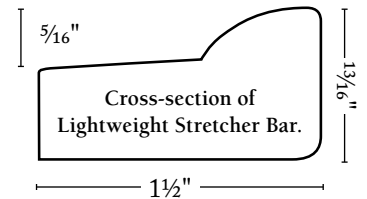

**See the Jack Richeson & Co. price list for lengths & item numbers**



*Don't forget cross braces for frames over 36" in length. See back page for recommended layouts.*

# BEST Aluminum Bars

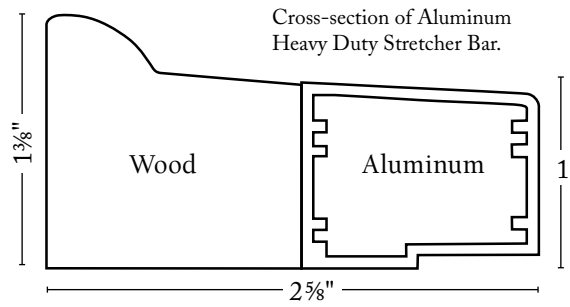
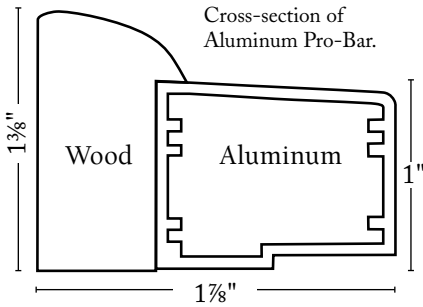

## Aluminum HD Stretcher Bar (Box of 6)

The BEST Aluminum HD Bar offers strength, stability, long length capability, and a larger stapling area. Full 1-3/8" area to staple on the back. We developed the Aluminum HD from our popular Heavy Duty bar and the Aluminum Pro, hence, the simple name! Keep it simple! Signature rounded profile allows the canvas to drape over the front eliminating "ghosting."

## Aluminum Pro Stretcher Bar (Box of 6)

Kiln-dried pine is connected to a specially milled 3/32" aluminum bar. Paintings will never twist, warp, bend or change due to dryness or humidity. The recycled aluminum stock provides a structural frame of total strength and stability. The pine outer bar offers a smooth, rounded edge and a solid surface for stapling. Pro-Bars can be cut to any length and assembled with steel corner inserts.

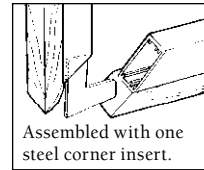

**Box Quantity waived for custom/special orders!**

**Aluminum Bars are available in standard stock in 1" increments from 8" to 144" (and beyond!)**

**Need fractional or exact sizes? Call 800.233.2404 for a quote.**

## Aluminum Gallery Wrap Stretcher Bars (Box of 6)

Aluminum Gallery Wrap stretcher bars are so beautiful, they don't even need a canvas! The 2.25" profile gives any canvased picture the depth it needs to come alive on a wall.

\*Uneven sizes are available. Fractions are custom cuts. Call for prices and stock numbers.

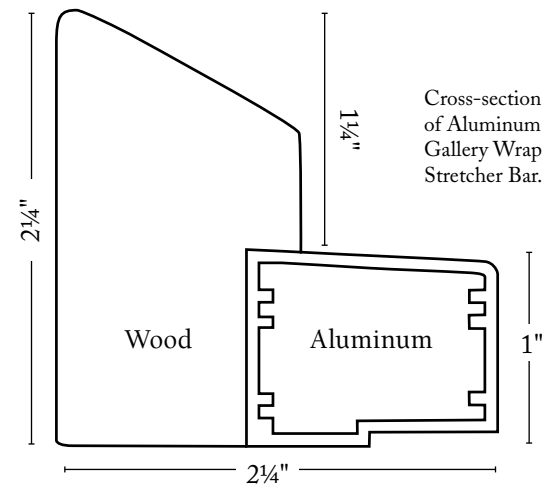

## Aluminum Corners\*

These steel corner inserts are only to be used with the BEST Aluminum Bars. Use 1 pack (4 corners) for small frames and two packs for heavy pieces or frames over 36" in length.

Sold in packs of 4.

\*Required for Aluminum Bars

Number 895020-04

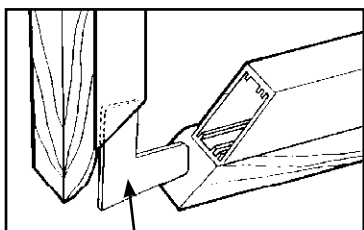

Aluminum Corner

## Splice Kit

JRC has developed a Splice Kit for aluminum bars that will allow you to have extra long lengths. 1 complete Splice Kit is needed per splice. The Splice Kit does not affect the integrity of the bar.

Number SK (Splice Kit)

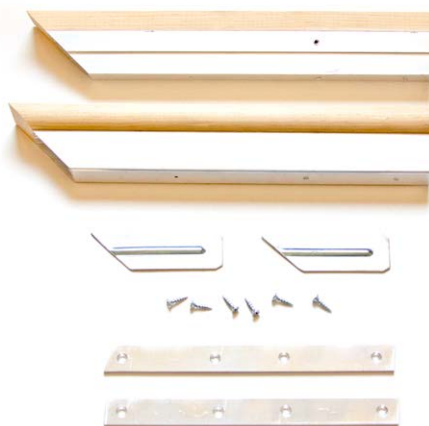

## Lap Joints

Lap Joints (SKBR) are used for cross braces. Placement is at the manufacturer's discretion. You can request that the holes be predrilled with assembly instructions for a set up charge (SET). Cost is determined by size of the frame.



**For Oversized Pieces**

Contact your sales representative for more details.

# Aluminum Bar Assembly



## Required Tools & Parts

### #893998 Assembly Kit

#893998 Assembly Kit Contains:

8 - Aluminum Corners\* | 8 - (16mm) 5/8" Screws | 4-Corner Keys\*\*

Rubber mallet | Square | Awl | 3/32" drill bit | Phillips screwdriver  
1/2" wrench | \* Recommended Hardboard Corners (not included)

\* #895020-04 4 pk. of Aluminum Corners also sold separately

\*\* #890048 4 pk. of BEST Corner Keys also sold separately

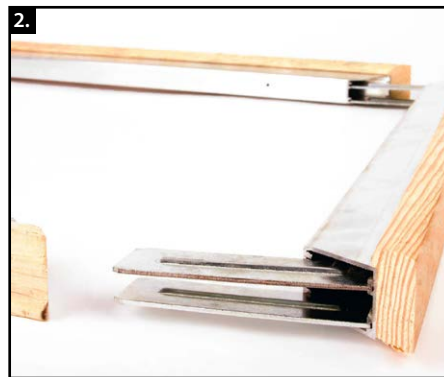
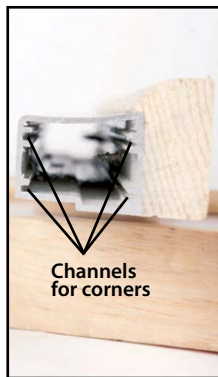

1. Insert corners into channels in aluminum bar (2 per corner). At this point assemble 3 of the bars.

2. Once 3 are assembled, put remaining corners in the remaining bar. Align corners with slots and insert.

3. Attach Best Keys with screws using pre-drilled holes.

#### 4. LAY FRAME FACE DOWN



4. Cross braces are recommended for any bar 36" or longer. If vertical & horizontal cross braces were ordered, they will come notched at the intersection for a flush fit. Bar notch charge #895015.

#### 5. ASSEMBLE CROSS BRACES



5. Attach notched braces in center in the center using a flat-head screw (not included). Single cross braces will simply attach to the bar frame using screws.

#### 6. DRILL CROSS BRACE HOLES



6. Cross braces are attached to the stretcher bar using the Best Cross Brace Bracket. Drill pilot hole in the stretcher bar with 3/32" drill bit, attach cross brace bracket & cross brace as shown.

# Cross Brace System

## Exclusive BEST Cross Brace Bracket

- State-of-the-art design works with all sizes of stretcher bars
- Slotted design allows for finest adjustment of canvas tension
- Allows bar frame to sit flat against a wall
- We recommend cross braces for any canvas over 36"
- Contains 2 brackets/10 screws
- One unit ships with each cross brace at no charge. Additional brackets available for extra cost.
- Number 895015

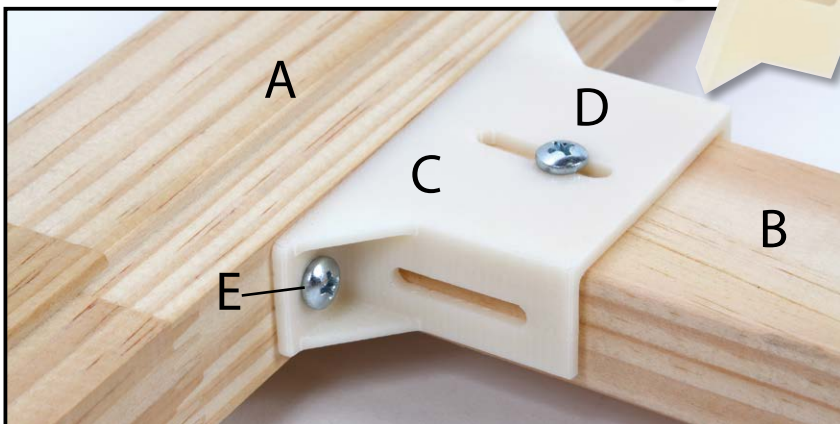

## How to assemble the Cross Brace Bracket

- Step 1** Assemble your stretcher bars (A).
- Step 2** Lay your cross braces into position.
- Step 3** Place your Richeson Cross Brace Bracket (C) #895015 at the end of your Cross Braces (B).
- Step 4** Attach bracket (C) to brace (B) with 1 to 3 screws (D) as desired. Do not overtighten.
- Step 5** Attach bracket (C) to pre-assembled frame from step 1 with 2 screws (E).
- Step 6** After canvas is tightly stretched, apply light pressure to brace and secure screw (D).

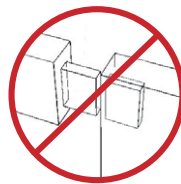

**Eliminates  
the need for  
costly tenon  
joints!**



## Ordering BEST Cross Braces

- Match up Cross Brace with same style Stretcher Bar (Example: Light-duty Bars with Light-duty Cross Braces to make a full Light-Duty Frame).
- Length of cross brace must match length of stretcher bar.
- See back page for a helpful Cross Brace Chart

**Call 800.233.2404 for pricing information and assistance.**

## BEST Corner Keys

A BEST Exclusive! Each pack contains a set of four keys that can be used on wood stretcher bar frames and Aluminum Pro Bars. Mount keys by using the pre-drilled holes on the Aluminum Pro Bars or by making your own with a 3/32" drill bit. The BEST keys are an essential tool for adjusting the tension of the canvas material just by the turn of a nut!

**Number 890048** \*Required for Aluminum Bars



**Corner Keys  
shown in use**



# Italian Caravaggio Rolls

See page 10 for a guide on stretching your canvas!

- Milled in Verese, Italy for over 30 years
- Europe's top acrylic primed canvas
- State of the art priming method delivers consistency
- Cotton, Linen, Jute, Polycotton, Cotton Linen, 100% Polyester
- Extra Fine, Fine, Universal Grain, Rough, Extra Rough
- 61"x 190", 61"x 390", 63"x190", 63"x 390", 83 x190", 83"x 390"
- Outstanding values! Available for drop ships!
- Call for a price sheet
- Order a swatch book - #30500000

**WEAVE KEY**  
S=Single D=Double \*=Denim

NUMBER	DOUBLE WHITE PRIMED SINGLE CLEAR PRIMED OIL PRIMED RAW UNPRIMED DESCRIPTION	TEXTURE	UNPRIMED GSM WT.	UNPRIMED OZ./METER	UNPRIMED OZ./YARD	PRIMED GSM WT.	PRIMED OZ./METER	PRIMED OZ./YARD	WEAVE	SIZES AVAILABLE (approximate in inches)
501	Cotton 75%, Polyester 25%	Medium	210	7	6	330	12	10	S	63x190, 63x390, 83x190, 83x390
502	Cotton 100%	Medium	220	8	6	310	11	9	D	83x190, 83x390
503	Cotton 100%	Extra Fine	135	5	4	230	8	7	S	83x190, 83x390
504	Polyester 100%	Extra Fine	125	4	4	220	8	6.5	S	83x190, 83x390
507	Polyester 67%, Cotton 33%	Fine	210	7	6	310	11	9	S	83x190, 83x390
508	Jute 100%	Extra Rough	300	10.5	9	500	18	15	S	83x190, 83x390
509	Linen 100%	Medium	280	10	8	470	16.5	14	S	61x190, 61x390, 83x190, 83x390, 84x190, 84x390
510	Linen 100%	Medium	240	8	7	-	-	-	S	84x190, 84x390
511	Linen 100%	Fine	220	8	6	380	13	11	S	83x190, 83x390
512	Linen 100%	Medium	280	10	8	420	15	12	S	83x190, 83x390, 84x190, 84x390
514	Linen 100%	Extra Fine	220	8	6	310	11	9	S	83x190, 83x390
515	Cotton 100%	Rough	245	9	7	310	11	9	D	83x190, 83x390
516	Linen 60%, Cotton 40%	Rough	280	10	8	420	15	12	D	83x190, 83x390
528	Cotton 100%	Fine	340	12	10	400	14	12	*	83x190, 83x390

Visit our website at [www.richesonart.com](http://www.richesonart.com) > Products > Caravaggio Canvas to learn more!

## Accessories

### Hardboard Corners

A simple but worthwhile accessory. These corners are an exact 90° angle to ensure that frame corners will remain square. The pre-drilled holes make mounting easy. Just screw one hardboard panel to each of the four corners of the frame. Sold in packs of 4 corners.

\*Screws not included.

Number	Description
895007-04	8" Corners (small paintings)
895008-04	12" Corners (large paintings)

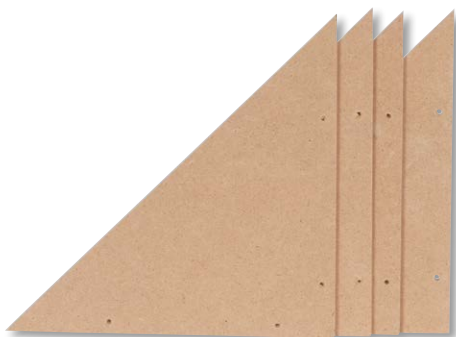

### Professional Canvas Pliers

**Strong! Durable! Lightweight!**  
This professional canvas pliers is large with 4 1/2" wide jaws with rubberized inside grip to hold canvas firmly without marring it.

Number 400302



### Canvas Pliers

Great for smaller canvases! These durable imported stretching pliers have serrated jaws for a secure grip to create an even, uniform stretching over stretcher strips or bars.

Number	Description
400300	Cast Iron Pliers
400301	Chrome Finish Pliers



# Canvas Stretching 101



**BEST**  
Stretcher Bars by Richeson

## Helpful Tools

Rubber mallet | Stapler | Scissors | Canvas Pliers | Awl | Screwdriver  
Recommended Hardboard Corners, BEST Keys (not included)



1. Start by stapling the middle of one side of stretcher bar; repeat on opposite side, pulling taut. Do the same for the other sides, always pulling the canvas taut.



2. Continue stapling working from the center to the corners making sure the staple spacing is even.



3. Please note, do not staple the canvas to the end of corners because you need enough room to manipulate the canvas for tucking the corners. Leave 1"-2".



4. BASIC CUT  
Trim the corners of excess canvas to eliminate bumps when you make a corner. Cut the "dog ear" on an angle.



5. Alt: cut out a square.



6. Begin your corner by folding the canvas straight along the front, fold the side canvas over the top.



7. Bend the first fold over the top of the side fold. Make sure corner lines are neat.



8. Optional: You can use canvas pliers to get the corner tight and flat.



9. Finish stapling.  
*Following steps are optional.*



Wood keys are tapped in the interior corner slots to adjust the tension of the canvas. Place a dab of wood glue on end to hold in place. Take care not to damage the canvas.



Some companies staple the corners. If you happen to get a canvas back that is sagging, you can use our BEST Corner Keys to remedy the problem. It's as easy as a turn of a nut! The Best Corner Key can be used on standard stretcher bars and our exclusive Aluminum Bars. If you staple, underpin, or glue your corners, this will break the seal to open the corners up to 1/8". Save time and money by not re-stretching the canvas, use BEST Keys!



# Furniture



OPTIONAL CASTERS SOLD SEPARATELY.

## Classic Dulce

Standard American studio easel designed to provide the artist with the most stable unit at a low price. Sturdy H-frame construction and laminated quad base offer superior strength and stability. Adjusts easily to a variety of custom settings.

- Maximum canvas height: 82"
- Base width/depth: 22" x 24"
- Compact easel height: 54"
- Extended easel height: 90"
- Folds flat for easy storage
- Adjustable sliding mast moves independent of canvas tray
- Wide bottom canvas holder with utility tray
- Base is pre-drilled for opt. casters
- Shipping weight: 37 lbs.
- Box dimensions: 55" x 29" x 6" OS
- Ships partially assembled by UPS

#880200



To see the complete furniture catalog, visit [www.richesonart.com](http://www.richesonart.com)



## Black Steel Print Rack

- Base width/depth: 34" x 18"
- Rack height: 32"
- Gusset: 6"
- Box dimensions: 34" x 23" x 4"
- Shipping weight: 16 lbs.
- Ships by UPS
- Assembly required

#696070



## Canvas Print Racks

These great print racks are lightweight and fold flat for easy storage! Support bed of black canvas that is sewn on to a sturdy, black 1" aluminum tube frame with rubber feet. Hand holes for carrying. Great way to display or store prints and paintings!

Number	Description
692042	Small - 15"(w) x 18"(h); Gusset 4"
692043	Medium - 20"(w) x 36"(h); Gusset 6"
692044	Large - 32"(w) x 36"(h); Gusset 6"

Great for displaying artwork or prints!



Print rack wood color and grain may vary.

### A. Large Galestio

- Base width/depth: 37" x 17"
- Rack height: 37"
- Box dimensions: 44" x 38" x 3"
- Shipping weight: 19 lbs.
- Ships by UPS - oversize
- Assembly required

#886019

### B. Medium Galestio

- Base width/depth: 23-3/4" x 16-1/2"
- Rack height: 33-3/4"
- Box dimensions: 39" x 25" x 3"
- Shipping weight: 15 lbs.
- Ships by UPS - oversize
- Assembly required

#886016

### Small Galestio

- Base width/depth: 20" x 15-1/2"
- Rack height: 31"
- Box dimensions: 37" x 21" x 3"
- Shipping weight: 11 lbs
- Ships by UPS. - oversize
- Assembly required

#886010

## Richeson Ambrosia Print Rack

- Base width/depth: 37" x 22"
- Rack height: 32"
- Gusset: 6 7/8"
- Box dimensions: 36" x 33" x 4"
- Shipping weight: 28 lbs. - oversize
- Ships UPS, assembly required

#886011

# Basic Cross Brace Layout

## Use this chart to determine cross braces needed

After beginning the BEST stretcher bar production in our plant, we devised this amazing basic cross brace layout plan that can help you plan for any size canvas.

- Always divide the gaps between the cross braces equally
- To find where the center of each cross brace should be:  
Total inches of the frame ÷ Number of cross braces used
- NOTE: Any bar requiring a splice kit must have an **even** number of cross braces.

144"	132"	120"	108"	96"	84"	72"	60"	48"	36"	24"	12"	
												12"
												24"
												36"
												48"
												60"
												72"
												84"
												96"
												108"
												120"
												132"
												144"



Jack Richeson & Co. understands the importance of forest stewardship. We have traveled the world to ensure that the wood used in manufacturing BEST Stretcher Bars are from well-managed forests. Our supplier of wood is FSC (Forest Stewardship Council) Accredited and SCS (Scientific Certification Systems) Certified Forest Conservation Program.

800.233.2404 (P)  
800.233.2545 (F)  
[www.richesonart.com](http://www.richesonart.com)